

# Optimal supply & Structure detection

## Complex Networks, SFI Summer School, June, 2010

Prof. Peter Dodds

Department of Mathematics & Statistics  
Center for Complex Systems  
Vermont Advanced Computing Center  
University of Vermont



Single Source

Distributed  
Sources

Facility location

Size-density law

A reasonable derivation

Global redistribution  
networks

Structure  
Detection

Hierarchy by division

Hierarchy by shuffling

Spectral methods

Hierarchies & Missing Links

General structure detection

Final words

References

Frame 1/78



# Outline

## Single Source

## Distributed Sources

Facility location

Size-density law

A reasonable derivation

Global redistribution networks

## Structure Detection

Hierarchy by division

Hierarchy by shuffling

Spectral methods

Hierarchies & Missing Links

General structure detection

## Final words

## References

Single Source

Distributed  
Sources

Facility location

Size-density law

A reasonable derivation

Global redistribution  
networks

Structure  
Detection

Hierarchy by division

Hierarchy by shuffling

Spectral methods

Hierarchies & Missing Links

General structure detection

Final words

References

## What's the best way to distribute stuff?

- ▶ Stuff = medical services, energy, nutrients, people, ...
- ▶ Some fundamental network problems:
  1. Distribute stuff from **single source** to **many sinks**
  2. Collect stuff coming from **many sources** at a **single sink**
  3. Distribute stuff from **many sources** to **many sinks**
  4. **Redistribute** stuff between many nodes
- ▶ **Q:** How do optimal solutions **scale with system size?**

Single Source

Distributed  
Sources

Facility location

Size-density law

A reasonable derivation

Global redistribution  
networks

Structure  
Detection

Hierarchy by division

Hierarchy by shuffling

Spectral methods

Hierarchies & Missing Links

General structure detection

Final words

References

# Single source optimal supply

## Basic Q for distribution/supply networks:

- ▶ How does flow behave given cost:

$$C = \sum_j I_j^\gamma Z_j$$

where

$I_j$  = current on link  $j$

and

$Z_j$  = link  $j$ 's impedance?

- ▶ Example:  $\gamma = 2$  for electrical networks.

Single Source

Distributed  
Sources

Facility location

Size-density law

A reasonable derivation

Global redistribution  
networks

Structure  
Detection

Hierarchy by division

Hierarchy by shuffling

Spectral methods

Hierarchies & Missing Links

General structure detection

Final words

References

# Single source optimal supply

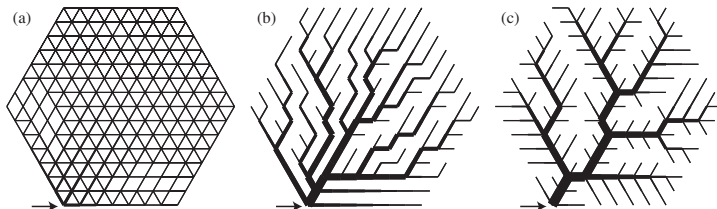

(a)  $\gamma > 1$ : Braided (bulk) flow

(b)  $\gamma < 1$ : Local minimum: Branching flow

(c)  $\gamma < 1$ : Global minimum: Branching flow

From Bohn and Magnasco<sup>[3]</sup>

See also Banavar et al.<sup>[1]</sup>

## Single Source

### Distributed Sources

- Facility location
- Size-density law
- A reasonable derivation
- Global redistribution networks

### Structure Detection

- Hierarchy by division
- Hierarchy by shuffling
- Spectral methods
- Hierarchies & Missing Links
- General structure detection

### Final words

### References

# Single source optimal supply

Single Source

Distributed  
Sources

Facility location

Size-density law

A reasonable derivation

Global redistribution  
networks

Structure  
Detection

Hierarchy by division

Hierarchy by shuffling

Spectral methods

Hierarchies & Missing Links

General structure detection

Final words

References

Optimal paths related to transport (Monge) problems:

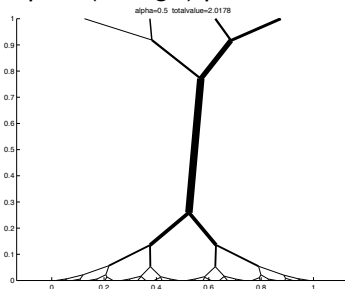
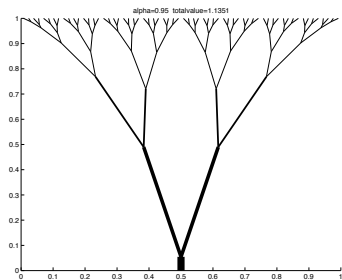

Xia (2003) [24]

# Growing networks:

FIGURE 1.  $\alpha = 0.6, \beta = 0.5$

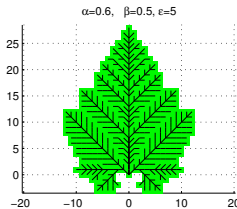
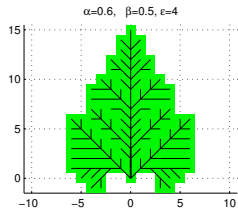
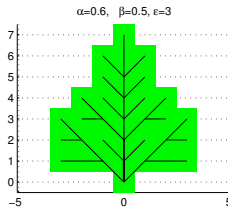
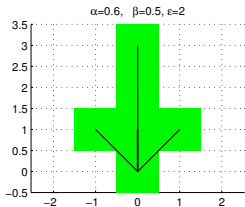

Xia (2007) [23]

Single Source

Distributed  
Sources

- Facility location
- Size-density law
- A reasonable derivation
- Global redistribution networks

Structure  
Detection

- Hierarchy by division
- Hierarchy by shuffling
- Spectral methods
- Hierarchies & Missing Links
- General structure detection

Final words

References

Frame 7/78

# Growing networks:

FIGURE 3. A maple leaf

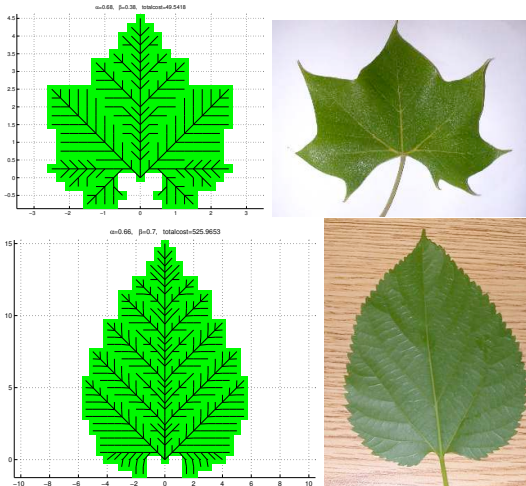

## Single Source

### Distributed Sources

- Facility location
- Size-density law
- A reasonable derivation
- Global redistribution networks

### Structure Detection

- Hierarchy by division
- Hierarchy by shuffling
- Spectral methods
- Hierarchies & Missing Links
- General structure detection

## Final words

## References



## An immensely controversial issue...

- ▶ The form of river networks and blood networks: optimal or not? [22, 2, 7]

## Two observations:

- ▶ Self-similar networks appear everywhere in nature for single source supply/single sink collection.
- ▶ Real networks differ in details of scaling but reasonably agree in scaling relations.

Single Source

Distributed  
Sources

Facility location

Size-density law

A reasonable derivation

Global redistribution  
networks

Structure  
Detection

Hierarchy by division

Hierarchy by shuffling

Spectral methods

Hierarchies & Missing Links

General structure detection

Final words

References

# Stream Ordering:

- ▶ Label all **source streams** as **order  $\omega = 1$** .
- ▶ Follow all labelled streams downstream
- ▶ Whenever two streams of the same order ( $\omega$ ) meet, the resulting stream has order incremented by 1 ( $\omega + 1$ ).
- ▶ If streams of different orders  $\omega_1$  and  $\omega_2$  meet, then the resultant stream has order equal to the largest of the two.
- ▶ Simple rule:

$$\omega_3 = \max(\omega_1, \omega_2) + \delta_{\omega_1, \omega_2}$$

where  $\delta$  is the Kronecker delta.

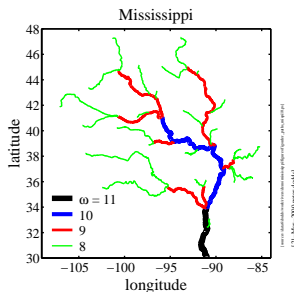



# Many scaling laws, many connections

relation:	scaling relation/parameter: [6]
$l \sim L^d$	$d$
$T_k = T_1(R_T)^{k-1}$	$T_1 = R_n - R_s - 2 + 2R_s/R_n$ $R_T = R_s$
$n_\omega/n_{\omega+1} = R_n$	$R_n$
$\bar{a}_{\omega+1}/\bar{a}_\omega = R_a$	$R_a = R_n$
$\bar{l}_{\omega+1}/\bar{l}_\omega = R_\ell$	$R_\ell = R_s$
$l \sim a^h$	$h = \log R_s / \log R_n$
$a \sim L^D$	$D = d/h$
$L_\perp \sim L^H$	$H = d/h - 1$
$P(a) \sim a^{-\tau}$	$\tau = 2 - h$
$P(l) \sim l^{-\gamma}$	$\gamma = 1/h$
$\Lambda \sim a^\beta$	$\beta = 1 + h$
$\lambda \sim L^\varphi$	$\varphi = d$

Single Source

Distributed  
Sources

Facility location

Size-density law

A reasonable derivation

Global redistribution  
networks

Structure  
Detection

Hierarchy by division

Hierarchy by shuffling

Spectral methods

Hierarchies & Missing Links

General structure detection

Final words

References

Only 3 parameters are independent... [6]

# Reported parameter values: [6]

Parameter:	Real networks:
$R_n$	3.0–5.0
$R_a$	3.0–6.0
$R_\ell = R_T$	1.5–3.0
$T_1$	1.0–1.5
$d$	$1.1 \pm 0.01$
$D$	$1.8 \pm 0.1$
$h$	0.50–0.70
$\tau$	$1.43 \pm 0.05$
$\gamma$	$1.8 \pm 0.1$
$H$	0.75–0.80
$\beta$	0.50–0.70
$\varphi$	$1.05 \pm 0.05$

## Single Source

### Distributed Sources

Facility location

Size-density law

A reasonable derivation

Global redistribution networks

### Structure Detection

Hierarchy by division

Hierarchy by shuffling

Spectral methods

Hierarchies & Missing Links

General structure detection

## Final words

## References

# Data from real blood networks

Network	$R_n$	$R_r^{-1}$	$R_\ell^{-1}$	$-\frac{\ln R_r}{\ln R_n}$	$-\frac{\ln R_\ell}{\ln R_n}$	$\alpha$
West <i>et al.</i>	–	–	–	0.5	0.33̄	0.75
rat (PAT)	2.76	1.58	1.60	0.45	0.46	0.73
cat (PAT) (Turcotte <i>et al.</i> [21])	3.67	1.71	1.78	0.41	0.44	0.79
dog (PAT)	3.69	1.67	1.52	0.39	0.32	0.90
pig (LCX)	3.57	1.89	2.20	0.50	0.62	0.62
pig (RCA)	3.50	1.81	2.12	0.47	0.60	0.65
pig (LAD)	3.51	1.84	2.02	0.49	0.56	0.65
human (PAT)	3.03	1.60	1.49	0.42	0.36	0.83
human (PAT)	3.36	1.56	1.49	0.37	0.33	0.94

Single Source

Distributed  
Sources

Facility location

Size-density law

A reasonable derivation

Global redistribution  
networks

Structure  
Detection

Hierarchy by division

Hierarchy by shuffling

Spectral methods

Hierarchies & Missing Links

General structure detection

Final words

References

Fundamental biological and ecological constraint:

$$P = c M^\alpha$$

$P$  = basal metabolic rate

$M$  = organismal body mass



Single Source

Distributed  
Sources

Facility location

Size-density law

A reasonable derivation

Global redistribution  
networks

Structure  
Detection

Hierarchy by division

Hierarchy by shuffling

Spectral methods

Hierarchies & Missing Links

General structure detection

Final words

References

# History

1964: Troon, Scotland:  
3rd symposium on energy metabolism.  
 $\alpha = 3/4$  made official ...



... 29 to zip.

## Single Source

### Distributed Sources

Facility location

Size-density law

A reasonable derivation

Global redistribution  
networks

### Structure Detection

Hierarchy by division

Hierarchy by shuffling

Spectral methods

Hierarchies & Missing Links

General structure detection

## Final words

## References



# Some data on metabolic rates

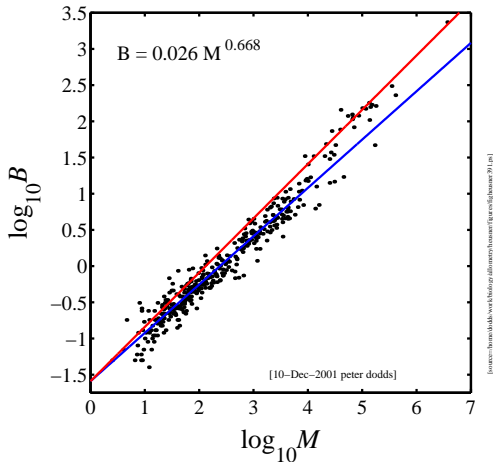

- ▶ Heusner's data (1991)<sup>[11]</sup>
- ▶ 391 Mammals
- ▶ blue line:  $2/3$
- ▶ red line:  $3/4$ .
- ▶ ( $B = P$ )

Single Source

Distributed Sources

- Facility location
- Size-density law
- A reasonable derivation
- Global redistribution networks

Structure Detection

- Hierarchy by division
- Hierarchy by shuffling
- Spectral methods
- Hierarchies & Missing Links
- General structure detection

Final words

References

# Some regressions from the ground up...

range of $M$	$N$	$\hat{\alpha}$
$\leq 0.1$ kg	167	$0.678 \pm 0.038$
$\leq 1$ kg	276	$0.662 \pm 0.032$
$\leq 10$ kg	357	$0.668 \pm 0.019$
$\leq 25$ kg	366	$0.669 \pm 0.018$
$\leq 35$ kg	371	$0.675 \pm 0.018$
$\leq 350$ kg	389	$0.706 \pm 0.016$
$\leq 3670$ kg	391	$0.710 \pm 0.021$

Single Source

Distributed  
Sources

Facility location

Size-density law

A reasonable derivation

Global redistribution  
networks

Structure  
Detection

Hierarchy by division

Hierarchy by shuffling

Spectral methods

Hierarchies & Missing Links

General structure detection

Final words

References

# Analysis of residuals—p-values—mammals:

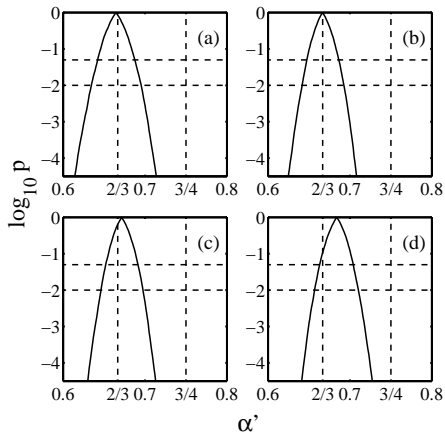

- ▶ (a)  $M < 3.2$  kg
  - (b)  $M < 10$  kg
  - (c)  $M < 32$  kg
  - (d) all mammals.
- ▶ For a-d,  
 $p_{2/3} > 0.05$  and  
 $p_{3/4} \ll 10^{-4}$ .

## Single Source

### Distributed Sources

Facility location

Size-density law

A reasonable derivation

Global redistribution networks

### Structure Detection

Hierarchy by division

Hierarchy by shuffling

Spectral methods

Hierarchies & Missing Links

General structure detection

## Final words

## References

# Analysis of residuals—p-values—birds:

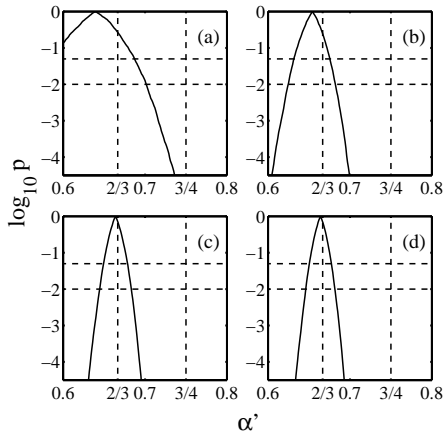

- ▶ (a)  $M < 0.1$  kg
- (b)  $M < 1$  kg
- (c)  $M < 10$  kg
- (d) all birds.
- ▶ For a-d,  
 $p_{2/3} > 0.05$  and  
 $p_{3/4} \ll 10^{-4}$ .

## Single Source

### Distributed Sources

- Facility location
- Size-density law
- A reasonable derivation
- Global redistribution networks

### Structure Detection

- Hierarchy by division
- Hierarchy by shuffling
- Spectral methods
- Hierarchies & Missing Links
- General structure detection

### Final words

### References

# Many sources, many sinks

## How do we distribute sources?

- ▶ Focus on 2-d (results generalize to higher dimensions)
- ▶ Sources = hospitals, post offices, pubs, ...
- ▶ **Key problem:** How do we cope with uneven population densities?
- ▶ Obvious: if density is uniform then sources are best distributed **uniformly**.
- ▶ Which lattice is optimal? The **hexagonal lattice**  
**Q1:** How big should the hexagons be?
- ▶ **Q2:** Given population density is uneven, what do we do?

Single Source

Distributed  
Sources

Facility location

Size-density law

A reasonable derivation

Global redistribution  
networks

Structure  
Detection

Hierarchy by division

Hierarchy by shuffling

Spectral methods

Hierarchies & Missing Links

General structure detection

Final words

References

## Solidifying the basic problem

- ▶ Given a region with some population distribution  $\rho$ , most likely uneven.
- ▶ Given resources to build and maintain  $N$  facilities.
- ▶ **Q:** How do we locate these  $N$  facilities so as to **minimize the average distance** between an individual's residence and the nearest facility?
- ▶ Problem of interest and studied by geographers, sociologists, computer scientists, mathematicians, ...
- ▶ See work by Stephan <sup>[19, 20]</sup> and by Gastner and Newman (2006) <sup>[8]</sup> and work cited by them.

Single Source

Distributed  
Sources

Facility location

Size-density law

A reasonable derivation

Global redistribution  
networks

Structure  
Detection

Hierarchy by division

Hierarchy by shuffling

Spectral methods

Hierarchies & Missing Links

General structure detection

Final words

References

# Optimal source allocation

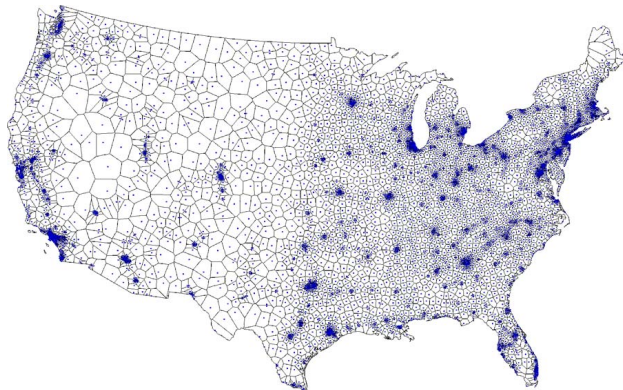

Gastner and Newman (2006) [8]

- ▶ Approximately optimal location of 5000 facilities.
- ▶ Based on 2000 Census data.
- ▶ Simulated annealing + Voronoi tessellation.

From

Single Source

Distributed  
Sources

Facility location

Size-density law

A reasonable derivation

Global redistribution  
networks

Structure  
Detection

Hierarchy by division

Hierarchy by shuffling

Spectral methods

Hierarchies & Missing Links

General structure detection

Final words

References

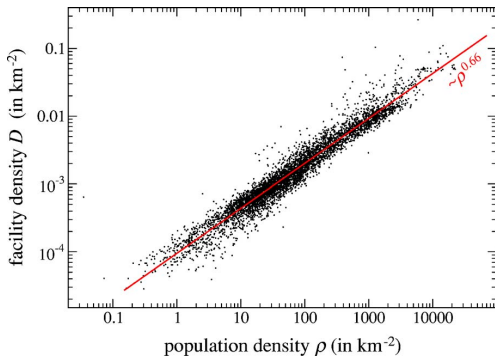

From Gastner and Newman (2006) [8]

- ▶ Optimal facility density  $D$  vs. population density  $\rho$ .
- ▶ Fit is  $D \propto \rho^{0.66}$  with  $r^2 = 0.94$ .
- ▶ Looking good for a 2/3 power...

Single Source

Distributed  
Sources

Facility location

Size-density law

A reasonable derivation

Global redistribution  
networks

Structure  
Detection

Hierarchy by division

Hierarchy by shuffling

Spectral methods

Hierarchies & Missing Links

General structure detection

Final words

References

Frame 25/78



## Size-density law:



$$D \propto \rho^{2/3}$$

- ▶ In  $d$  dimensions:

$$D \propto \rho^{d/(d+1)}$$

- ▶ Why?
- ▶ Very different story to branching networks where there is either one source or one sink.
- ▶ Now sources & sinks are distributed throughout region...

Single Source

Distributed  
Sources

Facility location

Size-density law

A reasonable derivation

Global redistribution  
networks

Structure  
Detection

Hierarchy by division

Hierarchy by shuffling

Spectral methods

Hierarchies & Missing Links

General structure detection

Final words

References

- ▶ One treatment due to Stephan's (1977) [19, 20]:  
“Territorial Division: The Least-Time Constraint Behind the Formation of Subnational Boundaries” (Science, 1977)
- ▶ Zipf-like approach: invokes **principle of minimal effort**.
- ▶ Also known as the Homer principle.

Single Source

Distributed Sources

Facility location

Size-density law

A reasonable derivation

Global redistribution networks

Structure Detection

Hierarchy by division

Hierarchy by shuffling

Spectral methods

Hierarchies & Missing Links

General structure detection

Final words

References

## Deriving the optimal source distribution:

- ▶ Stronger result obtained by Gusein-Zade (1982).<sup>[10]</sup>
- ▶ **Basic idea:** Minimize the average distance from a random individual to the nearest facility.
- ▶ Assume given a fixed population density  $\rho$  defined on a spatial region  $\Omega$ .
- ▶ Formally, we want to find the locations of  **$n$  sources**  $\{\vec{x}_1, \dots, \vec{x}_n\}$  that minimizes the **cost function**

$$F(\{\vec{x}_1, \dots, \vec{x}_n\}) = \int_{\Omega} \rho(\vec{x}) \min_i \|\vec{x} - \vec{x}_i\| d\vec{x}.$$

- ▶ Also known as the p-median problem.
- ▶ Not easy... in fact this one is an NP-hard problem.<sup>[8]</sup>

Single Source

Distributed  
Sources

Facility location

Size-density law

A reasonable derivation

Global redistribution  
networks

Structure  
Detection

Hierarchy by division

Hierarchy by shuffling

Spectral methods

Hierarchies & Missing Links

General structure detection

Final words

References

## Size-density law

Can (roughly) turn into a Lagrange multiplier story:

- ▶ By varying  $\{\vec{x}_1, \dots, \vec{x}_n\}$ , minimize

$$G(A) = c \int_{\Omega} \rho(\vec{x}) A(\vec{x})^{1/2} d\vec{x} - \lambda \left( n - \int_{\Omega} [A(\vec{x})]^{-1} d\vec{x} \right)$$

- ▶ Involves estimating typical distance from  $\vec{x}$  to the nearest source (say  $i$ ) as  $c_i A(\vec{x})^{1/2}$  where  $c_i$  is a shape factor for the  $i$ th Voronoi cell.
- ▶ **Sneakiness:** set  $c_i = c$ .
- ▶ Compute  $\delta G / \delta A$ , the functional derivative ( $\boxplus$ ).
- ▶ Solve and substitute  $D = 1/A$ , we find

$$D(\vec{x}) = \left( \frac{c}{2\lambda} \rho \right)^{2/3}.$$

Single Source

Distributed  
Sources

Facility location

Size-density law

A reasonable derivation

Global redistribution  
networksStructure  
Detection

Hierarchy by division

Hierarchy by shuffling

Spectral methods

Hierarchies &amp; Missing Links

General structure detection

Final words

References

Frame 31/78

## One more thing:

- ▶ How do we supply these facilities?
- ▶ How do we best redistribute mail? People?
- ▶ How do we get beer to the pubs?
- ▶ Gaster and Newman model: cost is a function of basic maintenance and travel time:

$$C_{\text{maint}} + \gamma C_{\text{travel}}.$$

- ▶ Travel time is more complicated: Take 'distance' between nodes to be a composite of shortest path distance  $\ell_{ij}$  and number of legs to journey:

$$(1 - \delta)\ell_{ij} + \delta(\#\text{hops}).$$

- ▶ When  $\delta = 1$ , only number of hops matters.

Single Source

Distributed  
Sources

Facility location

Size-density law

A reasonable derivation

Global redistribution  
networks

Structure  
Detection

Hierarchy by division

Hierarchy by shuffling

Spectral methods

Hierarchies & Missing Links

General structure detection

Final words

References

# Global redistribution networks

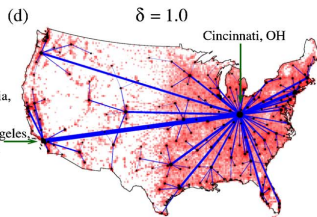
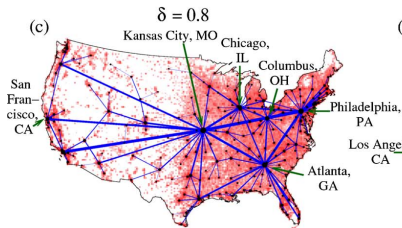
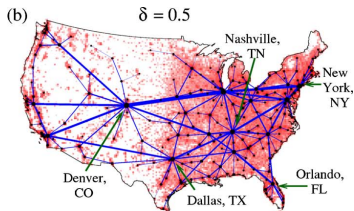
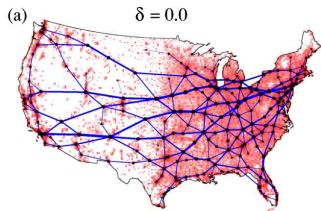

From Gastner and Newman (2006) [8]

Single Source

Distributed  
Sources

Facility location  
Size-density law  
A reasonable derivation  
Global redistribution  
networks

Structure  
Detection

Hierarchy by division  
Hierarchy by shuffling  
Spectral methods  
Hierarchies & Missing Links  
General structure detection

Final words

References

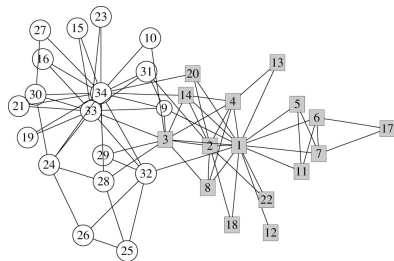

- ▶ **The issue:**  
how do we elucidate  
the internal structure  
of large networks  
across many scales?

## ▲ Zachary's karate club [25, 16]

- ▶ **Possible substructures:**  
hierarchies, cliques, rings, ...
- ▶ **Plus:**  
All combinations of substructures.
- ▶ Much focus on hierarchies...

Single Source

Distributed  
Sources

Facility location

Size-density law

A reasonable derivation

Global redistribution  
networks

Structure  
Detection

Hierarchy by division

Hierarchy by shuffling

Spectral methods

Hierarchies & Missing Links

General structure detection

Final words

References

# Hierarchy by division

## Top down:

- ▶ **Idea:** Identify **global structure first** and recursively uncover more detailed structure.
- ▶ **Basic objective:** find dominant components that have significantly more links within than without, as compared to randomized version.
- ▶ Following comes from “**Finding and evaluating community structure in networks**” by Newman and Girvan (PRE, 2004). [16]
- ▶ See also
  1. “**Scientific collaboration networks. II. Shortest paths, weighted networks, and centrality**” by Newman (PRE, 2001). [14, 15]
  2. “**Community structure in social and biological networks**” by Girvan and Newman (PNAS, 2002). [9]

Single Source

Distributed  
Sources

Facility location

Size-density law

A reasonable derivation

Global redistribution  
networks

Structure  
Detection

Hierarchy by division

Hierarchy by shuffling

Spectral methods

Hierarchies & Missing Links

General structure detection

Final words

References



# Hierarchy by division

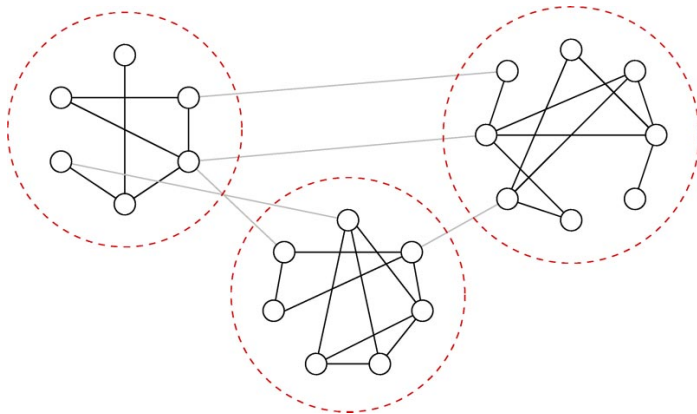

- ▶ *Idea:*  
Edges that **connect** communities have **higher betweenness** than edges **within** communities.

## One class of structure-detection algorithms:

1. Compute edge betweenness for whole network.
2. **Remove** edge with highest betweenness.
3. Recompute edge betweenness
4. Repeat steps 2 and 3 until all edges are removed.
- 5 Record when components appear as a function of # edges removed.
- 6 Generate **dendrogram** revealing hierarchical structure.

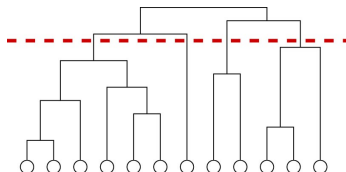

**Red line** indicates appearance of four (4) components at a certain level.

Single Source

Distributed  
Sources

Facility location

Size-density law

A reasonable derivation

Global redistribution  
networks

Structure  
Detection

Hierarchy by division

Hierarchy by shuffling

Spectral methods

Hierarchies & Missing Links

General structure detection

Final words

References

# Hierarchy by division

## Key element:

- ▶ Recomputing betweenness.
- ▶ **Reason:** Possible to have a low betweenness in links that connect large communities if other links carry majority of shortest paths.

## When to stop?:

- ▶ How do we know which divisions are meaningful?
- ▶ **Modularity measure:** difference in fraction of within component nodes to that expected for randomized version:

$$Q = \sum_i [e_{ii} - (\sum_j e_{ij})^2] = \text{Tr}\mathbf{E} - \|\mathbf{E}^2\|_1,$$

where  $e_{ij}$  is the fraction of edges between identified communities  $i$  and  $j$ .

Single Source

Distributed  
Sources

Facility location

Size-density law

A reasonable derivation

Global redistribution  
networksStructure  
Detection

Hierarchy by division

Hierarchy by shuffling

Spectral methods

Hierarchies &amp; Missing Links

General structure detection

Final words

References

## Test case:

- ▶ Generate random community-based networks.
- ▶  $N = 128$  with four communities of size 32.
- ▶ Add edges randomly within and across communities.
- ▶ Example:

$$\langle k \rangle_{\text{in}} = 6 \text{ and } \langle k \rangle_{\text{out}} = 2.$$

Single Source

Distributed  
Sources

Facility location

Size-density law

A reasonable derivation

Global redistribution  
networks

Structure  
Detection

Hierarchy by division

Hierarchy by shuffling

Spectral methods

Hierarchies & Missing Links

General structure detection

Final words

References

# Hierarchy by division

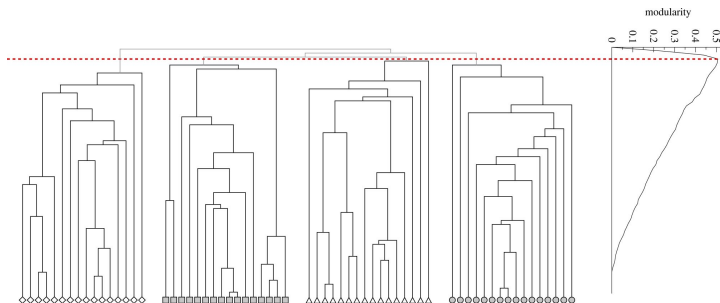

- ▶ Maximum modularity  $Q \simeq 0.5$  obtained when four communities are uncovered.
- ▶ Further 'discovery' of internal structure is somewhat meaningless, as any communities arise accidentally.

Single Source

Distributed Sources

Facility location  
Size-density law  
A reasonable derivation  
Global redistribution networks

Structure Detection

Hierarchy by division  
Hierarchy by shuffling  
Spectral methods  
Hierarchies & Missing Links  
General structure detection

Final words

References

# Hierarchy by division

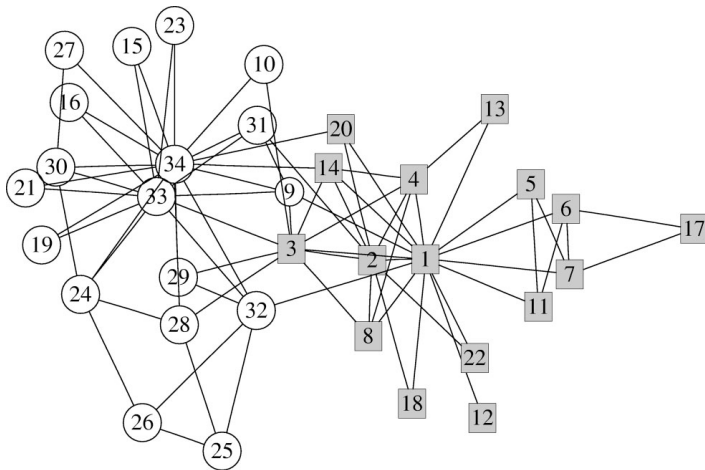

- **Factions in Zachary's karate club network.** [25]

Single Source

Distributed  
Sources

Facility location

Size-density law

A reasonable derivation

Global redistribution  
networks

Structure  
Detection

Hierarchy by division

Hierarchy by shuffling

Spectral methods

Hierarchies & Missing Links

General structure detection

Final words

References

# Betweenness for electrons:

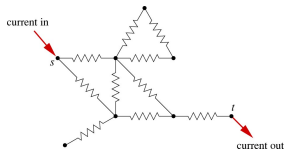

- ▶ Unit resistors on each edge.
- ▶ For every pair of nodes  $s$  (source) and  $t$  (sink), set up **unit currents** in at  $s$  and out at  $t$ .
- ▶ Measure absolute current along each edge  $\ell$ ,  $|I_{\ell, st}|$ .
- ▶ Sum  $|I_{\ell, st}|$  over all pairs of nodes to obtain **electronic betweenness** for edge  $\ell$ .
- ▶ (Equivalent to **random walk betweenness**.)
- ▶ Electronic betweenness for edge between nodes  $i$  and  $j$ :

$$B_{ij}^{\text{elec}} = a_{ij} |V_i - V_j|.$$

- ▶ **Upshot**: specific measure of betweenness not too important.

# Scientists working on networks

Optimal supply &  
Structure detection

(b)

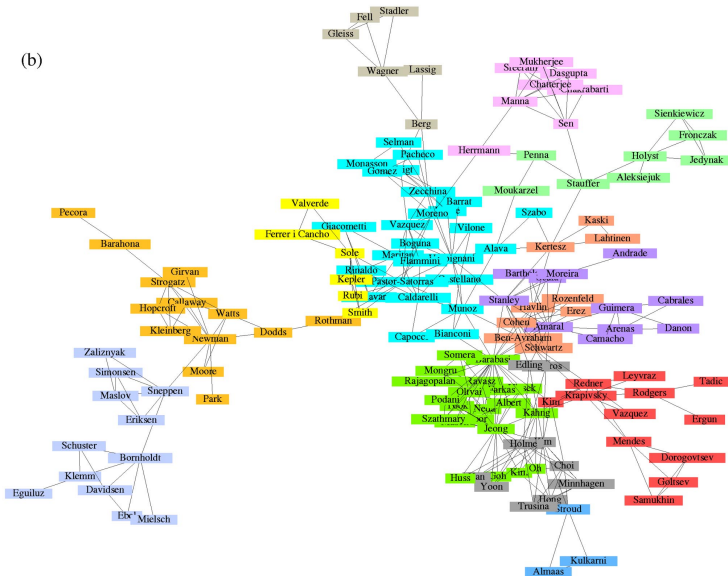

Single Source

Distributed  
Sources

- Facility location
- Size-density law
- A reasonable derivation
- Global redistribution networks

Structure  
Detection

- Hierarchy by division
- Hierarchy by shuffling
- Spectral methods
- Hierarchies & Missing Links
- General structure detection

Final words

References

Frame 45/78





# Scientists working on networks

Optimal supply &  
Structure detection

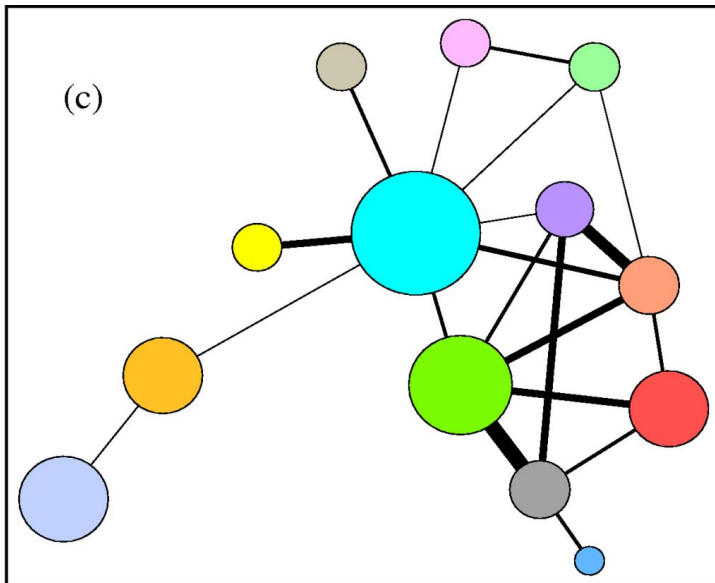

Single Source

Distributed  
Sources

Facility location

Size-density law

A reasonable derivation

Global redistribution  
networks

Structure  
Detection

Hierarchy by division

Hierarchy by shuffling

Spectral methods

Hierarchies & Missing Links

General structure detection

Final words

References

Frame 46/78

# Dolphins!

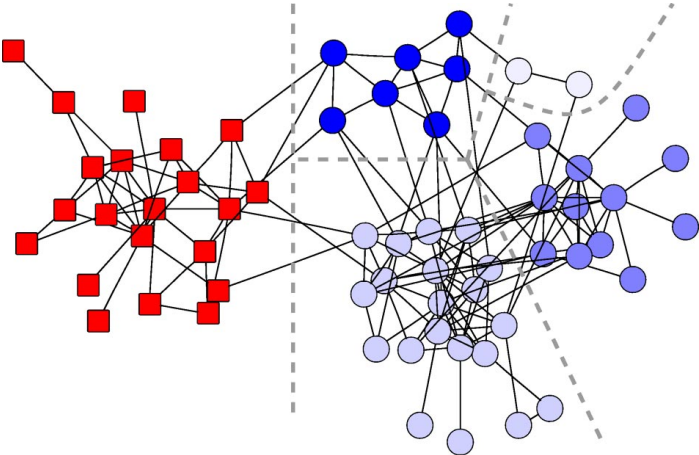

Single Source

Distributed Sources

- Facility location
- Size-density law
- A reasonable derivation
- Global redistribution networks

Structure Detection

- Hierarchy by division
- Hierarchy by shuffling
- Spectral methods
- Hierarchies & Missing Links
- General structure detection

Final words

References

# Les Miserables

Optimal supply &  
Structure detection

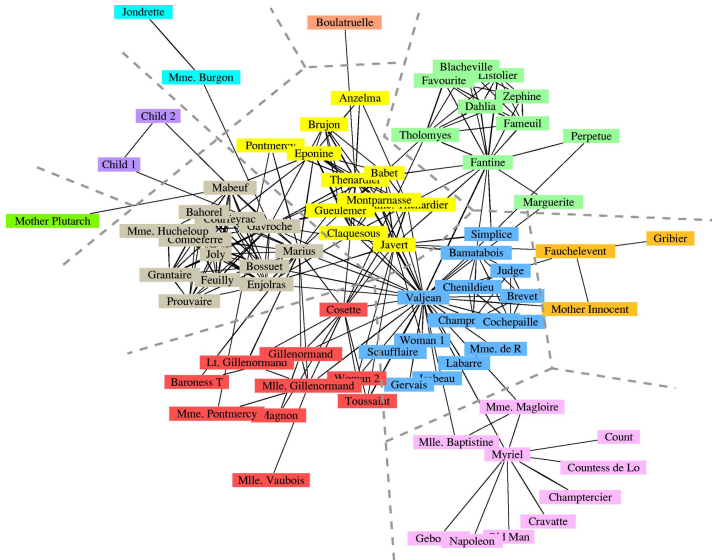

Single Source

Distributed  
Sources

- Facility location
- Size-density law
- A reasonable derivation
- Global redistribution networks

Structure  
Detection

- Hierarchy by division
- Hierarchy by shuffling
- Spectral methods
- Hierarchies & Missing Links
- General structure detection

Final words

References

Frame 48/78



- ▶ “Extracting the hierarchical organization of complex systems”  
Sales-Pardo *et al.*, PNAS (2007) [17, 18]
- ▶ Consider all partitions of networks into  $m$  groups
- ▶ As for Newman and Girvan approach, aim is to find partitions with maximum modularity:

$$Q = \sum_i [e_{ii} - (\sum_j e_{ij})^2] = \text{Tr}\mathbf{E} - \|\mathbf{E}^2\|_1.$$

Single Source

Distributed  
Sources

Facility location

Size-density law

A reasonable derivation

Global redistribution  
networks

Structure  
Detection

Hierarchy by division

Hierarchy by shuffling

Spectral methods

Hierarchies & Missing Links

General structure detection

Final words

References

- ▶ Consider **partition network**, i.e., the network of all possible partitions.
- ▶ **Defn:** Two partitions are connected if they differ only by the reassignment of a single node.
- ▶ Look for local maxima in partition network.
- ▶ Construct an **affinity matrix** with entries  $A_{ij}$ .
- ▶  $A_{ij} = \mathbf{Pr}$  random walker on modularity network ends up at a partition with  $i$  and  $j$  in the same group.
- ▶ C.f. **topological overlap** between  $i$  and  $j =$   
# matching neighbors for  $i$  and  $j$  divided by maximum of  $k_i$  and  $k_j$ .

Single Source

Distributed  
Sources

Facility location

Size-density law

A reasonable derivation

Global redistribution  
networks

Structure  
Detection

Hierarchy by division

Hierarchy by shuffling

Spectral methods

Hierarchies & Missing Links

General structure detection

Final words

References

# Shuffling for structure

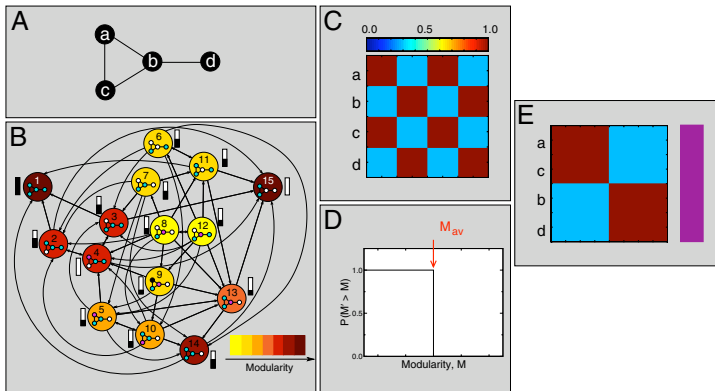

- ▶ **A:** Base network; **B:** Partition network; **C:** Coclassification matrix; **D:** Comparison to random networks (all the same!); **E:** Ordered coclassification matrix; Conclusion: no structure...

Single Source

Distributed Sources

Facility location

Size-density law

A reasonable derivation

Global redistribution networks

Structure Detection

Hierarchy by division

Hierarchy by shuffling

Spectral methods

Hierarchies & Missing Links

General structure detection

Final words

References

- ▶ Method obtains a distribution of classification hierarchies.
- ▶ Note: the hierarchy with the highest modularity score isn't chosen.
- ▶ Idea is to weight possible hierarchies according to their basin of attraction's size in the partition network.
- ▶ **Next step:** Given affinities, now need to sort nodes into modules, submodules, and so on.
- ▶ **Idea:** permute nodes to minimize following cost

$$C = \frac{1}{N} \sum_{i=1}^N \sum_{j=1}^N A_{ij} |i - j|.$$

- ▶ Use simulated annealing (slow).

Single Source

Distributed  
Sources

Facility location

Size-density law

A reasonable derivation

Global redistribution  
networks

Structure  
Detection

Hierarchy by division

Hierarchy by shuffling

Spectral methods

Hierarchies & Missing Links

General structure detection

Final words

References

# Shuffling for structure

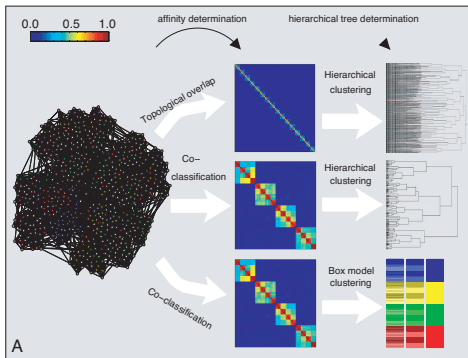

- ▶  $N = 640$ ,
- ▶  $\langle k \rangle = 16$ ,
- ▶ 3 tiered hierarchy.

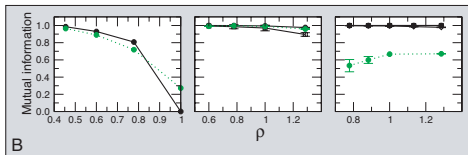

## Single Source

## Distributed Sources

- Facility location
- Size-density law
- A reasonable derivation
- Global redistribution networks

## Structure Detection

- Hierarchy by division
- Hierarchy by shuffling
- Spectral methods
- Hierarchies & Missing Links
- General structure detection

## Final words

## References



# Air transportation:

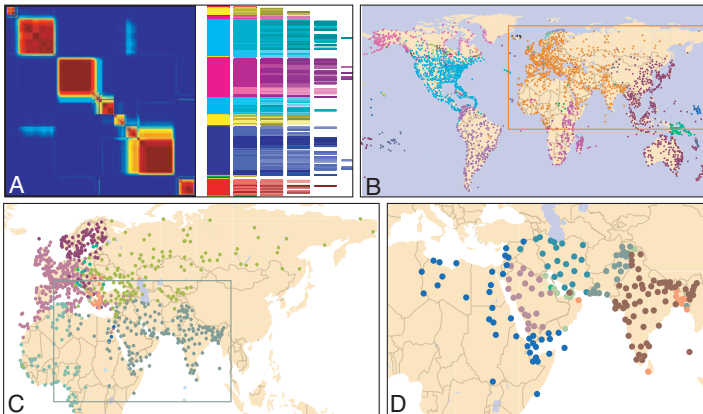

► Modules found match up with geopolitical units.

Single Source

Distributed  
Sources

- Facility location
- Size-density law
- A reasonable derivation
- Global redistribution networks

Structure  
Detection

- Hierarchy by division
- Hierarchy by shuffling
- Spectral methods
- Hierarchies & Missing Links
- General structure detection

Final words

References

- ▶ “Detecting communities in large networks”  
Capocci *et al.* (2005) [4]
- ▶ Consider normal matrix  $\mathbf{K}^{-1} \mathbf{A}$ , random walk matrix  $\mathbf{A}^T \mathbf{K}^{-1}$ , Laplacian  $\mathbf{K} - \mathbf{A}$ , and  $\mathbf{A} \mathbf{A}^T$ .
- ▶ Basic observation is that eigenvectors associated with secondary eigenvalues reveal evidence of structure.
- ▶ Build on Kleinberg’s HITS algorithm. [13]

Single Source

Distributed  
Sources

Facility location

Size-density law

A reasonable derivation

Global redistribution  
networks

Structure  
Detection

Hierarchy by division

Hierarchy by shuffling

Spectral methods

Hierarchies & Missing Links

General structure detection

Final words

References

# General structure detection

► Example network:

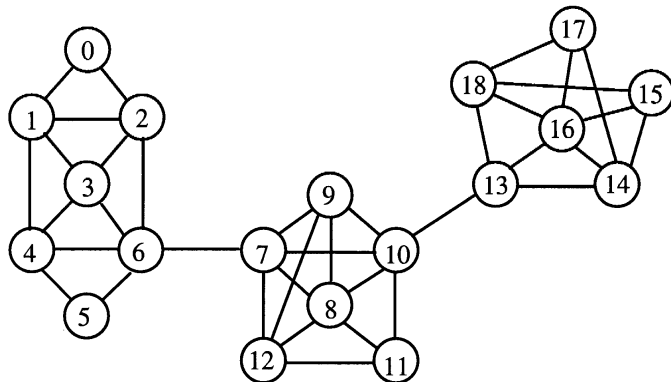

Single Source

Distributed  
Sources

Facility location

Size-density law

A reasonable derivation

Global redistribution  
networks

Structure  
Detection

Hierarchy by division

Hierarchy by shuffling

Spectral methods

Hierarchies & Missing Links

General structure detection

Final words

References

Frame 58/78

# General structure detection

► Second eigenvector's components:

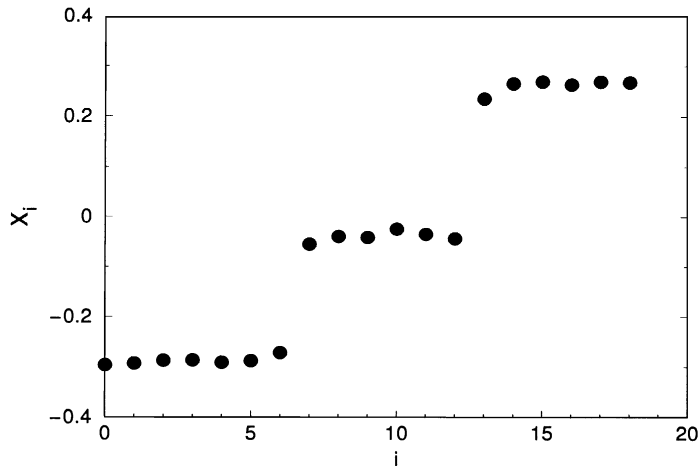

Single Source

Distributed  
Sources

Facility location

Size-density law

A reasonable derivation

Global redistribution  
networks

Structure  
Detection

Hierarchy by division

Hierarchy by shuffling

Spectral methods

Hierarchies & Missing Links

General structure detection

Final words

References

# Hierarchies and missing links

Clauset *et al.*, Nature (2008) [5]

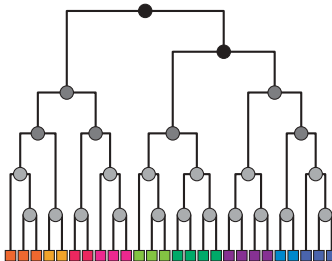
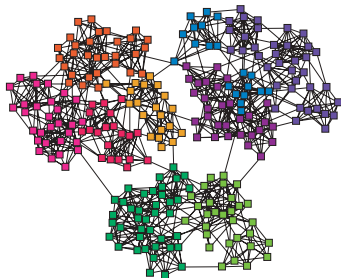

- ▶ Idea: Shades indicate probability that nodes in left and right subtrees of dendrogram are connected.
- ▶ Handle: **Hierarchical random graph models.**
- ▶ Plan: Infer **consensus dendrogram** for a given real network.
- ▶ Obtain probability that links are missing (big problem...).

- ▶ Model also predicts reasonably well
  1. average degree,
  2. clustering,
  3. and average shortest path length.

**Table 1 | Comparison of original and resampled networks**

Network	$\langle k \rangle_{\text{real}}$	$\langle k \rangle_{\text{samp}}$	$C_{\text{real}}$	$C_{\text{samp}}$	$d_{\text{real}}$	$d_{\text{samp}}$
<i>T. pallidum</i>	4.8	3.7(1)	0.0625	0.0444(2)	3.690	3.940(6)
Terrorists	4.9	5.1(2)	0.361	0.352(1)	2.575	2.794(7)
Grassland	3.0	2.9(1)	0.174	0.168(1)	3.29	3.69(2)

Statistics are shown for the three example networks studied and for new networks generated by resampling from our hierarchical model. The generated networks closely match the average degree  $\langle k \rangle$ , clustering coefficient  $C$  and average vertex-vertex distance  $d$  in each case, suggesting that they capture much of the structure of the real networks. Parenthetical values indicate standard errors on the final digits.

Single Source

Distributed  
Sources

Facility location

Size-density law

A reasonable derivation

Global redistribution  
networks

Structure  
Detection

Hierarchy by division

Hierarchy by shuffling

Spectral methods

Hierarchies & Missing Links

General structure detection

Final words

References

# Hierarchies and missing links

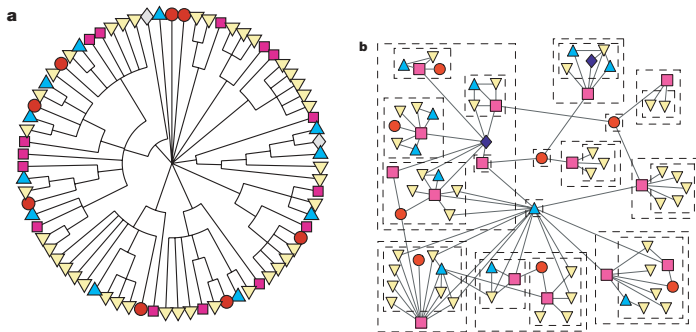

- ▶ Consensus dendrogram for grassland species.
- ▶ Copes with disassortative and assortative communities.

Single Source

Distributed Sources

Facility location

Size-density law

A reasonable derivation

Global redistribution networks

Structure Detection

Hierarchy by division

Hierarchy by shuffling

Spectral methods

Hierarchies & Missing Links

General structure detection

Final words

References





# General structure detection

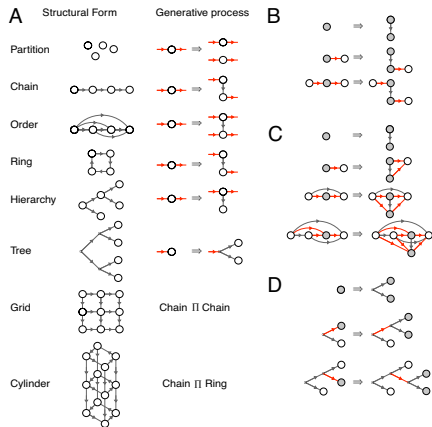

- ▶ Top down description of form.
- ▶ Node replacement graph grammar: parent node becomes two child nodes.
- ▶ B-D: Growing chains, orders, and trees.

Single Source

Distributed Sources

Facility location  
Size-density law  
A reasonable derivation  
Global redistribution networks

Structure Detection

Hierarchy by division  
Hierarchy by shuffling  
Spectral methods  
Hierarchies & Missing Links  
General structure detection

Final words

References

# General structure detection

► Performance for test networks.

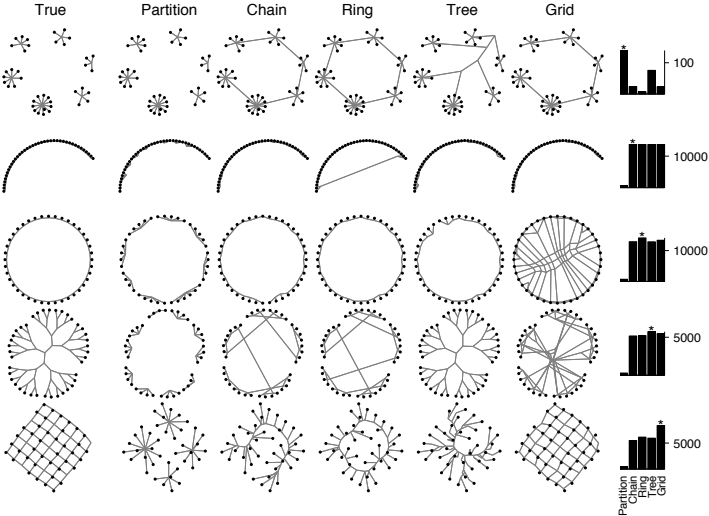

Single Source

Distributed Sources

- Facility location
- Size-density law
- A reasonable derivation
- Global redistribution networks

Structure Detection

- Hierarchy by division
- Hierarchy by shuffling
- Spectral methods
- Hierarchies & Missing Links
- General structure detection

Final words

References

# Example learned structures:

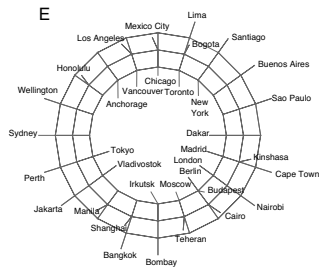
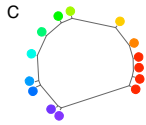
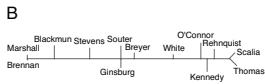
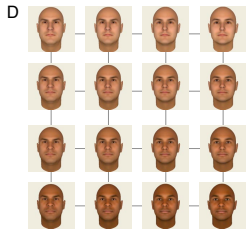
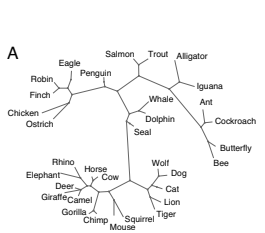

Single Source

Distributed Sources

- Facility location
- Size-density law
- A reasonable derivation
- Global redistribution networks

Structure Detection

- Hierarchy by division
- Hierarchy by shuffling
- Spectral methods
- Hierarchies & Missing Links
- General structure detection

Final words

References

- Biological features; Supreme Court votes; perceived color differences; face differences; & distances between cities.

# General structure detection

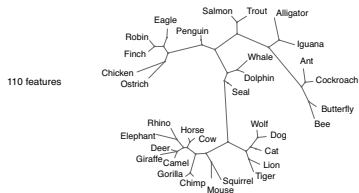
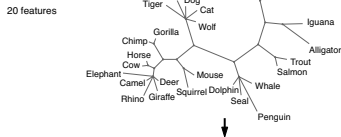
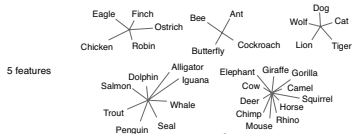

► Effect of adding features on detected form.

Straight partition



simple tree



complex tree

Single Source

Distributed Sources

- Facility location
- Size-density law
- A reasonable derivation
- Global redistribution networks

Structure Detection

- Hierarchy by division
- Hierarchy by shuffling
- Spectral methods
- Hierarchies & Missing Links
- General structure detection

Final words

References

# Final words:

## Science in three steps:

1. Find interesting/meaningful/important phenomena involving spectacular amounts of data.
2. Describe what you see.
3. Explain it.

## A plea/warning

**Beware your assumptions**—don't use tools/models because they're there, or because everyone else does...

# More final words:

## A real theory of everything:

1. Is not just about the small stuff...
2. It's about the increase of complexity

Symmetry breaking/  
Accidents of history      vs.      Universality

How probable is a certain level of complexity?

Single Source

Distributed  
Sources

Facility location

Size-density law

A reasonable derivation

Global redistribution  
networks

Structure  
Detection

Hierarchy by division

Hierarchy by shuffling

Spectral methods

Hierarchies & Missing Links

General structure detection

Final words

References

Frame 72/78



[1] J. R. Banavar, F. Colaiori, A. Flammini, A. Maritan, and A. Rinaldo.

Topology of the fittest transportation network.

*Phys. Rev. Lett.*, 84:4745–4748, 2000. [pdf](#) (田)



[2] J. R. Banavar, A. Maritan, and A. Rinaldo.

Size and form in efficient transportation networks.



*Nature*, 399:130–132, 1999. [pdf](#) (田)



[3] S. Bohn and M. O. Magnasco.

Structure, scaling, and phase transition in the optimal transport network.

*Phys. Rev. Lett.*, 98:088702, 2007. [pdf](#) (田)

-  [4] A. Capocci, V. Servedio, G. Caldarelli, and F. Colaiori.  
Detecting communities in large networks.  
*Physica A: Statistical Mechanics and its Applications*,  
352:669–676, 2005. [pdf](#) (田)
-  [5] A. Clauset, C. Moore, and M. E. J. Newman.  
Hierarchical structure and the prediction of missing  
links in networks.  
*Nature*, 453:98–101, 2008. [pdf](#) (田)
-  [6] P. S. Dodds and D. H. Rothman.  
Unified view of scaling laws for river networks.  
*Physical Review E*, 59(5):4865–4877, 1999. [pdf](#) (田)

Single Source

Distributed  
Sources

Facility location

Size-density law

A reasonable derivation

Global redistribution  
networks

Structure  
Detection

Hierarchy by division

Hierarchy by shuffling

Spectral methods

Hierarchies & Missing Links





General structure detection

Final words

References



# References III

-  [7] P. S. Dodds and D. H. Rothman.  
Geometry of river networks. I. Scaling, fluctuations,  
and deviations.  
*Physical Review E*, 63(1):016115, 2001. [pdf](#) (⊞)
-  [8] M. T. Gastner and M. E. J. Newman.  
Optimal design of spatial distribution networks.  
*Phys. Rev. E*, 74:016117, 2006. [pdf](#) (⊞)
-  [9] M. Girvan and M. E. J. Newman.  
Community structure in social and biological  
networks.  
*Proc. Natl. Acad. Sci.*, 99:7821–7826, 2002. [pdf](#) (⊞)
-  [10] S. M. Gusein-Zade.  
Bunge's problem in central place theory and its  
generalizations.  
*Geogr. Anal.*, 14:246–252, 1982.

Single Source

Distributed  
Sources

Facility location

Size-density law

A reasonable derivation

Global redistribution  
networks

Structure  
Detection

Hierarchy by division

Hierarchy by shuffling

Spectral methods





Hierarchies & Missing Links

General structure detection

Final words

References

# References IV

-  [11] A. A. Heusner.  
Size and power in mammals.  
*Journal of Experimental Biology*, 160:25–54, 1991.
-  [12] C. Kemp and J. B. Tenenbaum.  
The discovery of structural form.  
*Proc. Natl. Acad. Sci.*, 105:10687–10692, 2008.  
[pdf](#) (⊞)
-  [13] J. M. Kleinberg.  
Authoritative sources in a hyperlinked environment.  
*Proc. 9th ACM-SIAM Symposium on Discrete Algorithms*, 1998. [pdf](#) (⊞)
-  [14] M. E. J. Newman.  
Scientific collaboration networks. II. Shortest paths,  
weighted networks, and centrality.  
*Phys. Rev. E*, 64(1):016132, 2001. [pdf](#) (⊞)

Single Source

Distributed  
Sources

Facility location

Size-density law

A reasonable derivation

Global redistribution  
networks

Structure  
Detection

Hierarchy by division

Hierarchy by shuffling

Spectral methods



Hierarchies & Missing Links

General structure detection

Final words

References

# References V

-  [15] M. E. J. Newman.  
Erratum: Scientific collaboration networks. II.  
Shortest paths, weighted networks, and centrality  
[Phys. Rev. E 64, 016132 (2001)].  
*Phys. Rev. E*, 73:039906(E), 2006. [pdf](#) (⊞)
-  [16] M. E. J. Newman and M. Girvan.  
Finding and evaluating community structure in  
networks.  
*Phys. Rev. E*, 69(2):026113, 2004. [pdf](#) (⊞)
-  [17] M. Sales-Pardo, R. Guimerà, A. A. Moreira, and  
L. A. N. Amaral.  
Extracting the hierarchical organization of complex  
systems.  
*Proc. Natl. Acad. Sci.*, 104:15224–15229, 2007.  
[pdf](#) (⊞)

Single Source

Distributed  
Sources

Facility location

Size-density law

A reasonable derivation

Global redistribution  
networks

Structure  
Detection

Hierarchy by division

Hierarchy by shuffling

Spectral methods





Hierarchies & Missing Links

General structure detection

Final words

References

# References VI

-  [18] M. Sales-Pardo, R. Guimerà, A. A. Moreira, and L. A. N. Amaral.  
Extracting the hierarchical organization of complex systems: Correction.  
*Proc. Natl. Acad. Sci.*, 104:18874, 2007. [pdf](#) (田)
-  [19] G. E. Stephan.  
Territorial division: The least-time constraint behind the formation of subnational boundaries.  
*Science*, 196:523–524, 1977. [pdf](#) (田)
-  [20] G. E. Stephan.  
Territorial subdivision.  
*Social Forces*, 63:145–159, 1984. [pdf](#) (田)
-  [21] D. L. Turcotte, J. D. Pelletier, and W. I. Newman.  
Networks with side branching in biology.  
*Journal of Theoretical Biology*, 193:577–592, 1998.

Single Source

Distributed  
Sources

Facility location

Size-density law

A reasonable derivation

Global redistribution  
networks

Structure  
Detection

Hierarchy by division

Hierarchy by shuffling

Spectral methods





Hierarchies & Missing Links

General structure detection

Final words

References

## References VII

-  [22] G. B. West, J. H. Brown, and B. J. Enquist.  
A general model for the origin of allometric scaling laws in biology.  
*Science*, 276:122–126, 1997. [pdf](#) (田)
-  [23] Q. Xia.  
The formation of a tree leaf.  
Submitted. [pdf](#) (田)
-  [24] Q. Xia.  
Optimal paths related to transport problems.  
*Communications in Contemporary Mathematics*, 5:251–279, 2003. [pdf](#) (田)
-  [25] W. W. Zachary.  
An information flow model for conflict and fission in small groups.  
*J. Anthropol. Res.*, 33:452–473, 1977.

Single Source

Distributed  
Sources

Facility location

Size-density law

A reasonable derivation

Global redistribution  
networks

Structure  
Detection

Hierarchy by division

Hierarchy by shuffling

Spectral methods

Hierarchies & Missing Links

General structure detection

Final words

References